

# Bloccaggi Ferno

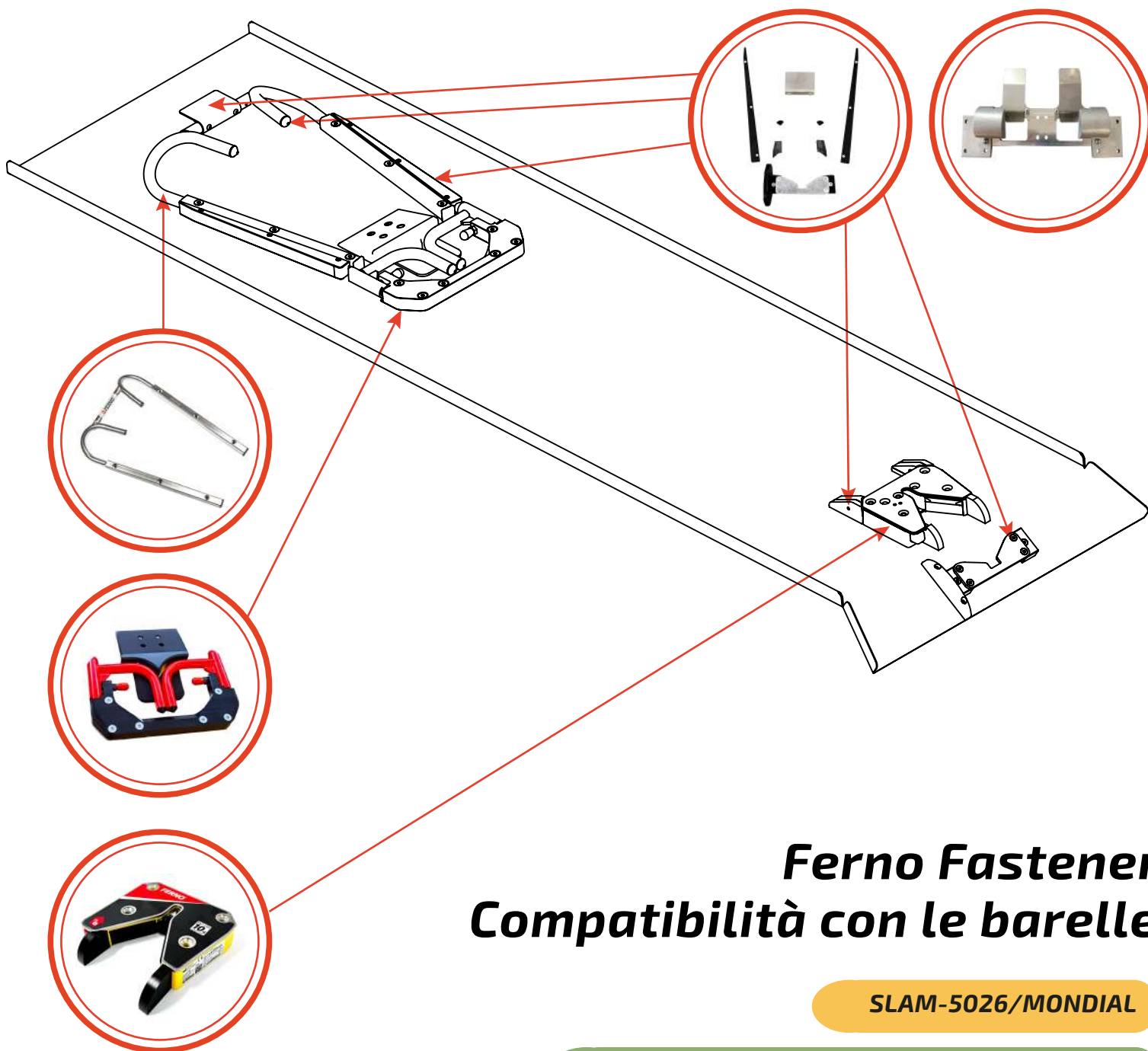

## Ferno Fastener Compatibilità con le barelle

SLAM-5026/MONDIAL

SLAM-5026/MONDIAL + 25-000125 + 25-000126

21-00048

SLAM-5026/MONDIAL + 21-00048

21-00049

# Le tue barelle

## Serie 5026, Cortex e Custom



5126-EL-IT / 5226-EL-IT

CORTEX

CUSTOM

## Serie 5026, Cortex, Custom e Mondial



5126-EL-IT / 5226-EL-IT

CORTEX

CUSTOM

MONDIAL

## Serie 26



26-S

26-B

## Serie 26, della serie 5026, Cortex, Custom



26-S

26-B

5126-EL-IT / 5226-EL-IT

CORTEX

CUSTOM

## Serie 26, della serie 5026, Cortex, Custom e Mondial



26-S

26-B

5126-EL-IT / 5226-EL-IT

CORTEX

CUSTOM

MONDIAL

## BLOCCAGGIO NECESSARIO

**CODICE:**  
SLAM-5026/MONDIAL

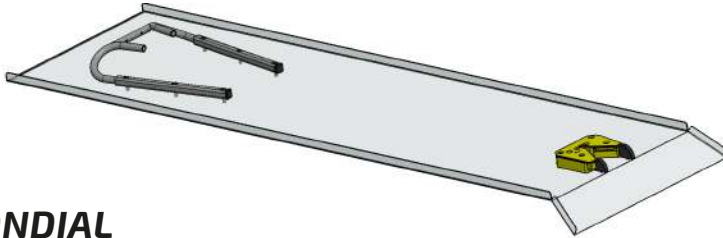

**CODICI:**  
SLAM-5026/MONDIAL  
25-000125  
25-000126

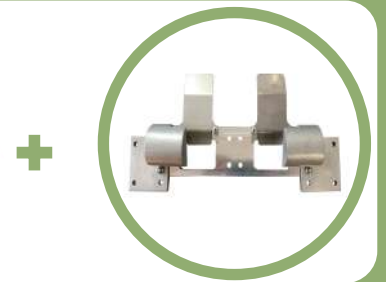
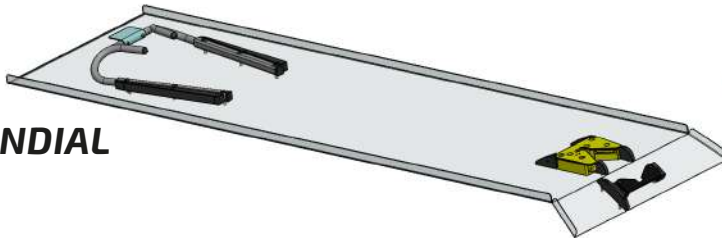

**CODICE:**  
SLAM-26

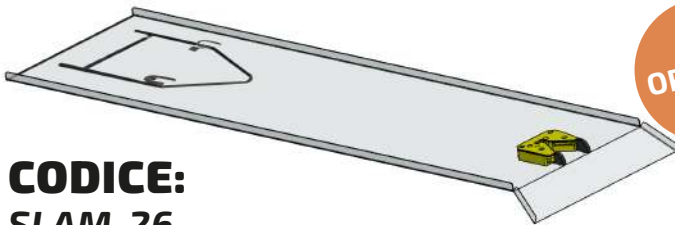

OPPURE

**CODICE:**  
21-00048

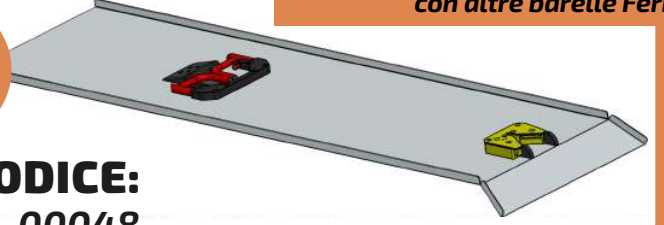

*Predisposizione per compatibilità  
con altre barelle Ferno*

**CODICI:**  
SLAM-5026/MONDIAL  
21-00040

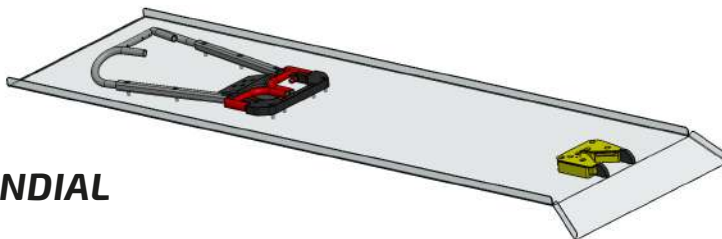

**CODICE:**  
21-00049

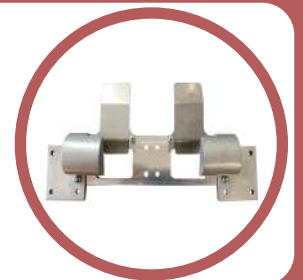
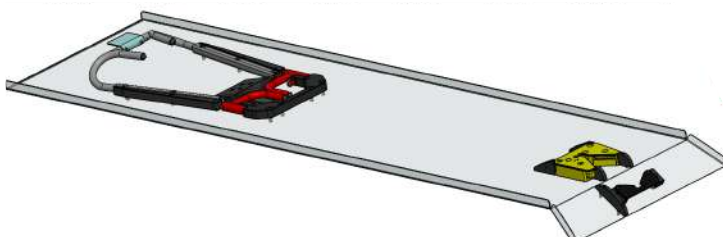

# Le varie componenti

Puoi effettuare in ogni momento un upgrade sul tuo pianale, per aumentare le tipologie di barelle da utilizzare sul tuo mezzo.

Bloccaggio SLAM

Multi Stretcher  
Fastener

Bloccaggio ad  
uncino 5026

Adapter Mondial  
Kit Barella

Adapter Mondial  
Kit pianale

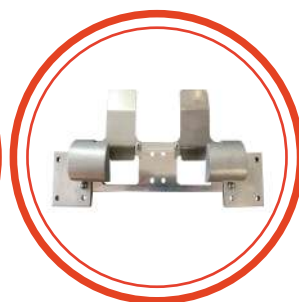
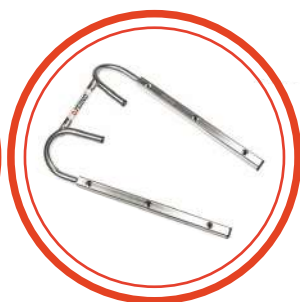

**CODICE:**  
SLAM

**CODICE:**  
21-00040

**CODICE:**  
25-0111-002

**CODICE:**  
25-00125

**CODICE:**  
25-00126

## Adapter Mondial (Kit Barella) - COD. 25-00125

Per bloccare correttamente la tua barella Mondial, oltre all'Adapter Mondial sul pianale, avrai necessità anche dell'Adapter Mondial Kit Barella, che andrà installato direttamente sul tuo presidio.

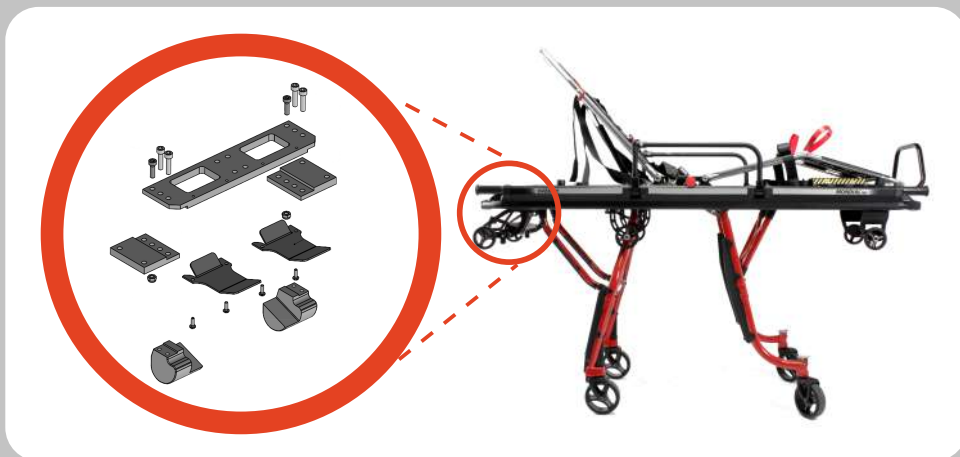

## Certificazioni

- Testato secondo UNI EN 1789.
- Testato 10G.
- Marchio CE.

Rel. 17032025

 **FERNO**<sup>®</sup>

Italy  
T: +39 051 68 600 28  
info.it@ferno.com  
www.ferno.it

Schweiz  
T: +41 41 259 60 00  
info.ch@ferno.com  
www.ferno.it